

TRANSFORMER RECTIFIERS

Perfection in transformer rectifier production

Perfection is the goal of our innovative dialogue process with endusers. We think of our customers as partners and we act accordingly. These dialogues provide requirements, concepts, products with high claim to quality - quality of the materials, quality of the customer benefit, quality of manufacture.

We achieve perfection and quality by dedicated research, expert development and design. It is ensured by particularly stringent quality control/assurance and test methods. Only transformer rectifiers which meet the highest standards are ready for shipment and installation.



The continuous development of user oriented complete solutions in the manufacturing of transformer rectifiers is one of the major goals of our company.

This development work is reflected in our manufacturing program. It provides all options and configurations for an infinite number of applications.

We use specially developed computer software and AUTOCAD to solve issues with design, component selection, climate conditions, etc., providing a complete solution in one process.

A plan quickly becomes the final answer with ultimate benefit for the user.



- **Air-cooled**
for normal climatic and ambient conditions
- **Oil-cooled**
for special climatic conditions such as high humidity and high ambient temperature
- **Explosion proof**
for hazardous classified areas in explosion proof enclosures

DC power equipment, such as transformer rectifiers, supplies current applied for the cathodic protection of buried or immersed metal structures. Transformer rectifiers are normally used when AC power from the mains is available.

GCP cathodic protection rectifiers are specially designed for operation in aggressive environments. These may include areas with corrosive, abrasive or high saline conditions, areas with high levels of dust, excess moisture or increased risk of high electrical discharge - all factors which may be detrimental to the operational life of the units.

Depending on ambient conditions and locations, air-cooled, oil-cooled or explosion proof units are generally used in CP systems.

Our transformer rectifiers are designed to meet German Standards (DIN/VDE) and the Standards of the International Electrotechnical Commission (IEC), but can also be designed in accordance with the requirements of other recognised Standards.

All transformer rectifiers can be used in indoor and outdoor locations and are capable of supplying continuous, full-rated output at ambient temperatures of up to +60°C.

Type: TR-AC-01**Microprocessor controlled units**

Further technical details can be found in Chapter 10

Document 10-100-R2

CORROCONTROL-2

The variable output controller units are equipped with a specially designed microprocessor which can be set to operate the transformer rectifiers in any one of the following three automatic output control modes:

- **Constant voltage mode**
automatically maintains **DC output voltage** at a preset level. Level can be continuously adjusted from any value between zero and maximum rating
- **Constant current mode**
automatically maintains **DC output current** at a preset level. Level can be continuously adjusted from any value between zero and maximum rating
- **Potential control mode**
automatic control to maintain the **structure-to-electrolyte potential** at preset level in response by a signal from a reference electrode

Other features

- operating mode is selectable by four programmed buttons on the front panel
- modern 1 MHz switcher with efficiency up to 90% at 24 -10 A
- protection against current surges in operation mode
- all data input and measuring values are displayed on a 2-line alphanumeric LCD display
- failure indication by LED
- built-in current interrupter for on/off measurements
- menu settings and readings programmable in different languages
- in case of network power failure, the unit automatically reverts to the last programmed operating mode. All preset values are retained.

The transformer rectifier is mounted on a 19" rack convenient indoor or outdoor installation (depending on type of enclosure).

All transformer rectifier control modules are provided on printed circuit boards.

Parallel operation

The transformer rectifiers can be connected in parallel to increase the DC output power if required.

**Master-slave parallel operation**

One master unit can drive 4 slave units. A slave unit can drive 4 further slave units. In parallel operation, the output current will be distributed equally amongst the slave units. The master-slave combination functions can be adjusted or programmed via the master unit.

Technical data

AC input	single or three phase 230 V \pm 10 %, 50 or 60 Hz single or three phase 400 V \pm 10 %, 50 or 60 Hz other voltages or frequencies on request
DC output	up to 50 A, up to 50 V, max. 2.5 kW
Control method	Standard: Constant voltage, stepless adjustment
Protection class	depending on enclosure
Temperature	ambient temperature: max 50° C, min. -20° C
Current limit	protection against current overloading
Thermal protection	a thermostat disconnects the output in case of unit overheating

Options

- Manually controlled output regulation devices
- Remote Monitoring and Control Systems (RMCS)

TRANSFORMER RECTIFIERS

TR-AC-02: Air-cooled, single or multiple module

Document No.: 02-102-R1

Sheet: 1 of 2

German Cathodic Protection



Type: Single or multiple output module TR-AC-02

Designed for cathodic protection systems in industrial plants such as: power plants; petrochemical plants; pump stations; tank terminals and compressor stations.

The number of required modules depends on the cathodic protection system.

Microprocessor controlled units

Further technical details can be found in Chapter 10

Document 10-100-R2

CORROCONTROL-2

The variable output controller units are equipped with a specially designed microprocessor which can be set to operate the transformer rectifiers in any one of the following three automatic output control modes:

- **Constant voltage mode**
automatically maintains **DC output voltage** at a preset level. Level can be continuously adjusted from any value between zero and maximum rating
- **Constant current mode**
automatically maintains **DC output current** at a preset level. Level can be continuously adjusted from any value between zero and maximum rating
- **Potential control mode**
automatic control to maintain the **structure-to-electrolyte potential** at preset level in response by a signal from a reference electrode

Other features

- operating mode is selectable by four programmed buttons on the front panel
- modern 1 MHz switcher with efficiency up to 90% at 24 V-10 A
- protection against current surges in operation mode
- all data input and measuring values are displayed on a 2-line alphanumeric LCD display
- failure indication by LED
- built-in current interrupter for on/off measurements
- menu settings and readings programmable in different languages
- in case of network power failure, the unit automatically reverts to the last programmed operating mode. All preset values are retained.

The transformer rectifier is mounted on a 19" rack convenient indoor or outdoor installation (depending on type of enclosure).

All transformer rectifier control modules are provided on printed circuit boards.



Technical data

AC input	single or three phase 230 V \pm 10 %, 50 or 60 Hz single or three phase 400 V \pm 10 %, 50 or 60 Hz other voltages or frequencies on request
DC output	up to 50 A, up to 50 V, max. 2.5 kW
Control method	Standard: Constant voltage, stepless adjustment
Protection class	depending on enclosure
Temperature	ambient temperature: max 50° C, min. -20° C
Current limit	protection against current overloading
Thermal protection	a thermostat disconnects the output in case of unit overheating

Operating modes

- manual operation on site
- via company network
- via Wlan

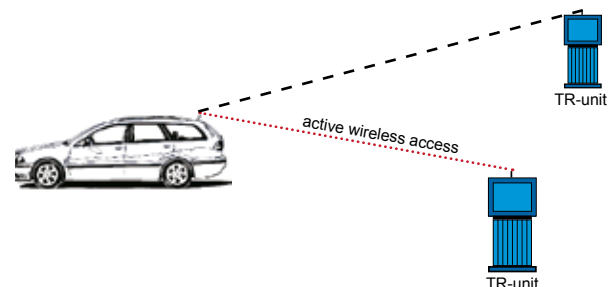

TRANSFORMER RECTIFIERS

TR-AC-02: Air-cooled, single or multiple module

Document No.: 02-102-R1

Sheet: 2 of 2

German Cathodic Protection



Type: Multiple output module TR-AC-02 with touchscreen operation and monitoring



Cost-effective operation and monitoring

Range includes 3.5" to 15" displays, keypad or touch screen controls. Panels designed with the IP65 protection class for optimal viewing even in severe climatic conditions. Additional advantages include integrated software functions, such as a reporting system, recipe management, or graph functions.

Example configuration:
PROJECT MOMBASA PORT KENYA
 Multiple output module TR-AC-02 with touchscreen operation and monitoring for 48 protection areas



Output control modes as described on Sheet: 1

GCP German Cathodic Protection
www.gcp.de / kahle@gcp.de

Area 01	Area 02	Area 03	Area 04	Area 05	Area 06	Area 07	Area 08
U = 0.00 V I = 0 mA M = Voltage	U = 0.00 V I = 0 mA M = Voltage	U = 0.00 V I = 0 mA M = Voltage	U = 0.00 V I = 0 mA M = Voltage	U = 0.00 V I = 0 mA M = Voltage	U = 0.00 V I = 0 mA M = Voltage	U = 0.00 V I = 0 mA M = Voltage	U = 0.00 V I = 0 mA M = Voltage
Area 09	Area 10	Area 11	Area 12	Area 13	Area 14	Area 15	Area 16
U = 0.00 V I = 0 mA M = Voltage	U = 0.00 V I = 0 mA M = Voltage	U = 0.00 V I = 0 mA M = Voltage	U = 0.00 V I = 0 mA M = Voltage	U = 0.00 V I = 0 mA M = Voltage	U = 0.00 V I = 0 mA M = Voltage	U = 0.00 V I = 0 mA M = Voltage	U = 0.00 V I = 0 mA M = Voltage
Area 17	Area 18	Area 19	Area 20	Area 21	Area 22	Area 23	Area 24
U = 0.00 V I = 0 mA M = Voltage	U = 0.00 V I = 0 mA M = Voltage	U = 0.00 V I = 0 mA M = Voltage	U = 0.00 V I = 0 mA M = Voltage	U = 0.00 V I = 0 mA M = Voltage	U = 0.00 V I = 0 mA M = Voltage	U = 0.00 V I = 0 mA M = Voltage	U = 0.00 V I = 0 mA M = Voltage
Area 25	Area 26	Area 27	Area 28	Area 29	Area 30	Area 31	Area 32
U = 0.00 V I = 0 mA M = Voltage	U = 0.00 V I = 0 mA M = Voltage	U = 0.00 V I = 0 mA M = Voltage	U = 0.00 V I = 0 mA M = Voltage	U = 0.00 V I = 0 mA M = Voltage	U = 0.00 V I = 0 mA M = Voltage	U = 0.00 V I = 0 mA M = Voltage	U = 0.00 V I = 0 mA M = Voltage
Area 33	Area 34	Area 35	Area 36	Area 37	Area 38	Area 39	Area 40
U = 0.00 V I = 0 mA M = Voltage	U = 0.00 V I = 0 mA M = Voltage	U = 0.00 V I = 0 mA M = Voltage	U = 0.00 V I = 0 mA M = Voltage	U = 0.00 V I = 0 mA M = Voltage	U = 0.00 V I = 0 mA M = Voltage	U = 0.00 V I = 0 mA M = Voltage	U = 0.00 V I = 0 mA M = Voltage
Area 41	Area 42	Area 43	Area 44	Area 45	Area 46	Area 47	Area 48
U = 0.00 V I = 0 mA M = Voltage	U = 0.00 V I = 0 mA M = Voltage	U = 0.00 V I = 0 mA M = Voltage	U = 0.00 V I = 0 mA M = Voltage	U = 0.00 V I = 0 mA M = Voltage	U = 0.00 V I = 0 mA M = Voltage	U = 0.00 V I = 0 mA M = Voltage	U = 0.00 V I = 0 mA M = Voltage

System Service Area

Detail Output No.: 1

GCP German Cathodic Protection
www.gcp.de / kahle@gcp.de

ACTUAL VALUES

Output Voltage: **0.00 V**

Output Current: **0 mA**

Control Mode: **Voltage**

SETTINGS

Set Voltage: **0.00 V**

Set Current: **0 mA**

Set Control Mode: **Voltage**

Exit and save

GCP German Cathodic Protection
www.gcp.de / kahle@gcp.de

Current Interrupter: **ACTIVE**

TAKT ON / 6.635s

TAKT OFF / 3s

CURRENT INTERRUPTER ON / OFF

Detail Output No.: 4

GCP German Cathodic Protection
www.gcp.de / kahle@gcp.de

ACTUAL VALUES

Output Voltage: **0.00 V**

Output Current: **0 mA**

Control Mode: **Voltage**

SETTINGS

Set Voltage: **0.00 V**

Set Current: **0 mA**

Set Control Mode: **Voltage**

Exit and save

Manufacturer : **GCP German Cathodic Protection GmbH ,Co. KG**
 Am Luftschacht 23, 45307 Essen, Germany
 Tel.: +49-201-618187-0, Fax.: +49-201-618187-10, Email: kahle@gcp.de, www.gcp.de

Serial number: 103025-001

IP Address: Controller XXX.XXX.XXX.XXX
 VPN GSM Modem XXX.XXX.XXX.XXX
 Touchscreen XXX.XXX.XXX.XXX

Exit

TRANSFORMER RECTIFIERS

Oil-cooled, Type: TR-OC-01

Document No.: 02-201-R2

Sheet: 1 of 1

German Cathodic Protection



Type: TR-OC-01

Oil-cooled transformer rectifiers are specially designed for safe, reliable and long operational lifetimes in harsh environments. The transformer rectifier components are housed in steel enclosures with separate sections for the oil tank and the control cabinet. The oil tank is a heavy-duty welded steel enclosure. Side walls made of specially corrugated steel sheets increase the cooling surface area. A top steel cover is bolted and sealed to the tank.

The oil tank is equipped with the following standard fittings:

- Oil filling cap and drain plug
- Thermometer with integrated oil level gauge
- Silica gel breather
- Earthing terminal
- Lifting lugs and rating plate

The main transformer, auto-transformer or thyristor module, rectifier and all components producing heat loss during operation are fixed on a fabricated steel rack, welded to the tank top cover and immersed in oil.

Located on the top of the oil tank, the control cabinet has hinged and lockable front and rear doors. Both doors can also be fastened in the fully open position.

Control and metering equipment is located at the front of the cabinet which also has a toughened glass windows for convenient meter reading.

Test sockets are provided underneath each meter to allow for independent readings using portable meters. Hot dip galvanised steel conduits are installed on the rear for cable entry and fixing.

The back part of the cabinet is used for the connection of surge diverters, circuit breakers, shunts, etc.

The transformer rectifier is supplied with a base frame and fixing bolts for plinth mounting. The control cabinets can also be supplied with sunshades.

A transformer rectifier comprises a main transformer, an auto-transformer or thyristor modules, a stack of selenium or silicon rectifiers and other auxiliaries/accessories such as protection devices, meters, switches, fuses, indicating lamps, enclosure, etc.

The transformer rectifiers are designed to meet the German Standards (DIN/VDE) and the Standards of the International Electrotechnical Commission (IEC), but can also be designed in accordance with other recognised Standards.

The transformer rectifiers are built for years of rugged service.

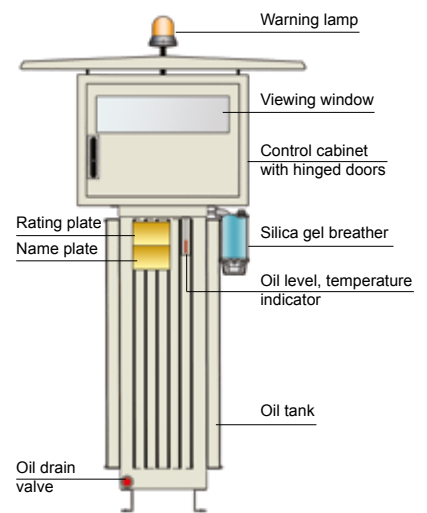

Technical data

AC input	single or three phase 230 V ± 10 %, 50 or 60 Hz single or three phase 400 V ± 10 %, 50 or 60 Hz other voltages or frequencies on request
DC output	up to 1000 A, up to 100 V, max. 10 kW
Control method	Standard: Constant voltage, stepless adjustment
Protection class	IP 55 acc. to IEC 529
Temperature	ambient temperature: max 55° C, min. -10° C
Transformer oil	acc. to DIN 57370, VDE 0370
Painting	galvanising of inner and outer surfaces finished in several coats of colour RAL 9010

The following output control modes are selectable by touchscreen operation and monitoring:

- **Constant voltage mode**
automatically maintains **DC output voltage** at a preset level. Level can be continuously adjusted from any value between zero and maximum rating
- **Constant current mode**
automatically maintains **DC output current** at a preset level. Level can be continuously adjusted from any value between zero and maximum rating
- **Potential control mode**
automatic control to maintain the **structure-to-electrolyte potential** at preset level in response by a signal from a reference electrode
- **Current Interrupter mode**
- REMOTE MONITORING AND CONTROL (CORROCONTROL-2)

Control cabinet with touchscreen operation and monitoring

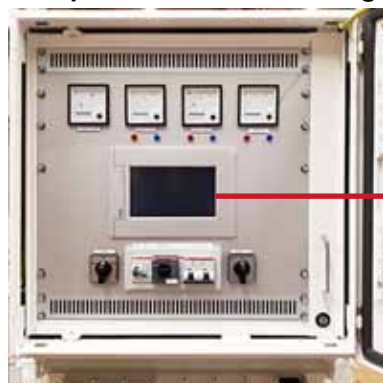

Touch Displays

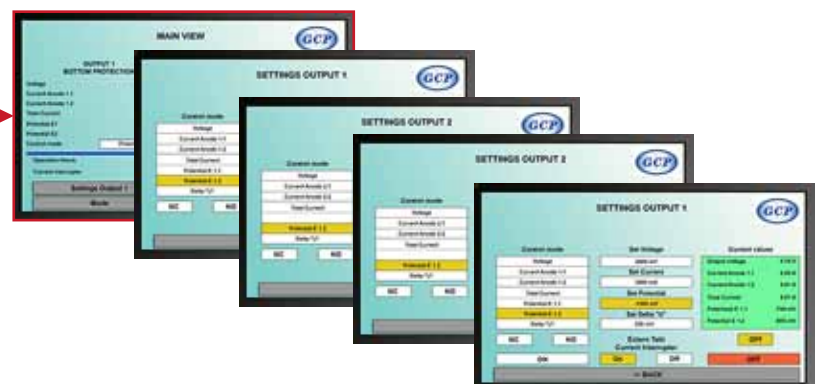

TRANSFORMER RECTIFIERS

Air-cooled-portable, Type: TR-ACP-01

Document No.: 02-109-R1

Sheet: 1 of 1

German Cathodic Protection



Type: TR-ACP-01

Portable transformer rectifiers are used for carrying out current drain tests to determine the resistance of corrosion protective coating on pipelines and the current density required for producing the desired swing in the existing potential of the object to be provided with cathodic protection.

Portable transformer rectifiers are designed for easy handling and transportation and for use in harsh environmental conditions. The enclosure can be made of sheet steel, stainless steel, aluminium or glass-fibre polyester with weather-proof protection up to IP 65.

Portable transformer rectifiers consist of a variable ratio transformer which allows continuous adjustment of output voltage from zero to maximum rated voltage and built-in meters for measurement of output voltage and current.

Test sockets are provided underneath each meter for more accurate measurements/calibration using portable instruments.

Units are equipped with a built-in quartz controlled current interrupter for on/off potential measurements .

Front panel with colour coded DC output terminals (positive=red, negative=blue).



AC Input:	single phase 230 V \pm 10%, 50 or 60 Hz
DC output current:	0 - 20 A
DC output voltage:	0 - 50 V
Max. DC power output:	1 kW
Protection class:	depending on enclosure

other voltages, frequencies or output rates available on request

TRANSFORMER RECTIFIERS Compensating current limitation unit

Document No.: 02-120-R1

Sheet: 1 of 1

German Cathodic Protection



Type: CCLU-01

On long-distance routes, several pipelines often run parallel in a corridor, and they are often protected by a common CP unit with individual cathode cable connections for each pipeline.

Depending on the age and quality of their pipeline coatings, the current demand for each pipeline may vary considerably, thus causing extremely high potential differences at the drain point.

This can result not just in the insufficient protection of poorly coated pipelines or an excess protection for well coated pipelines, worse still it can result in the circulation of uncontrolled currents between the pipelines which can cause corrosion or decrease the effectiveness of the CP system.

The CCLU enables the individual adjustment of current for each pipeline circuit and prevents the circulation of uncontrolled current between the pipelines, thus guaranteeing uniform potential levels. The CCLU can be installed in the transformer rectifier or separately according to customer specifications.

Description

The unit mainly consists of several current paths depending on the number of pipelines to be connected.

Each current path consists of :

- BLOCKING DIODE to prevent the flow of current between pipelines
- VARIABLE RESISTOR to adjust the magnitude of current for each pipeline
- SURGE PROTECTION CASCADE to protect the components against overvoltage
- SHUNTS AND METERS for total and individual current measurements
- TERMINALS for cable connections

The type of components (diodes, variable resistors, surge protection cascades, meters, shunts, etc.) depends on the total output current of the CP unit and the single current of each individual pipeline.

The enclosure for the unit can be made of sheet steel, stainless steel, aluminium or non-metallic material such as glass-fibre reinforced polyester with weatherproof protection up to IP 65, and suitable for pole, wall or plinth mounting.

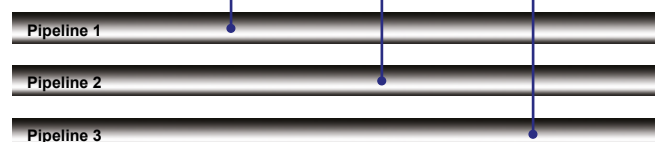
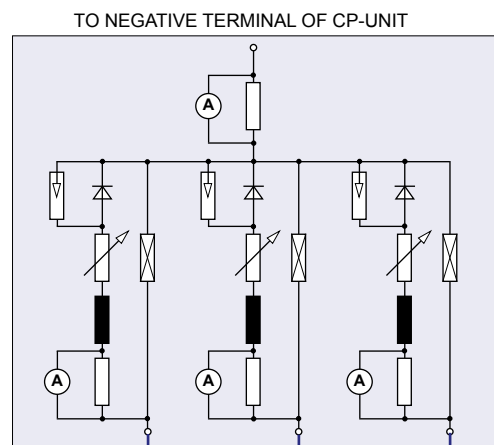

TRANSFORMER RECTIFIERS

Residual voltage compensating unit

Document No.: 02-150-R1

Sheet: 1 of 1

German Cathodic Protection



Residual voltage compensating unit for insulating flanges type: RVCU-01

The problem of corrosion inside insulating flanges is well known. It is caused by the potential difference between the two flange sides, for example, where oil, gas or water wells and connected flowlines are cathodically protected by two separate systems because of different required current densities. The residual voltage compensating unit has been developed to eliminate such potential differences at insulating flanges without reducing the efficiency of the cathodic protection system.

Specification

	RVCU-01 (Residual Voltage)	RVCU-01 (Potential)
Input resistance R_i	25 kOhm	650 kOhm
Output resistance R_o	1 kOhm	1 kOhm
Input voltage U_i	± 10 mV... ± 5 V	0...-5 V
Output voltage U_o	$U_{min}^{1)}...$ 10 V	$U_{min}^{1)}...$ 10 V
AC input	230 V, 50 Hz	230 V, 50 Hz
Operating temp. range	-25 °C / +85 °C	-25 °C / +85 °C
Permanent input protection	240 V rms	240 V rms
Permanent separation voltage	1 500 V rms	1 500 V rms
Transient protection	acc. to IEEE-472	acc. to IEEE-472
Interference rejection	160 dB	160 dB
Amplifier mode :		
Input voltage U_i	± 10 mV... ± 5 V	± 5 V
Output voltage U_o	± 5 V	± 5 V
Gain	max. 500	max. 1
Accuracy	± 0.05 %	± 0.05 %
	± 10 μ V RTI	± 0.2 mV RTI
Linearity	± 0.02 %	± 0.02 %
Drift	± 1 μ V (Offset U_i)	± 20 μ V (Offset U_i)
	± 20 μ V (Offset U_o)	± 20 μ V (Offset U_o)

¹⁾ is determined through basic current setting



Characteristics

- automatic control without system deviation
- insulating flange compensation to zero
- accurate potential control by potential grading
- non-oscillating control characteristics
- negligible electromagnetic interference
- high input protection
- galvanic separation between input and output

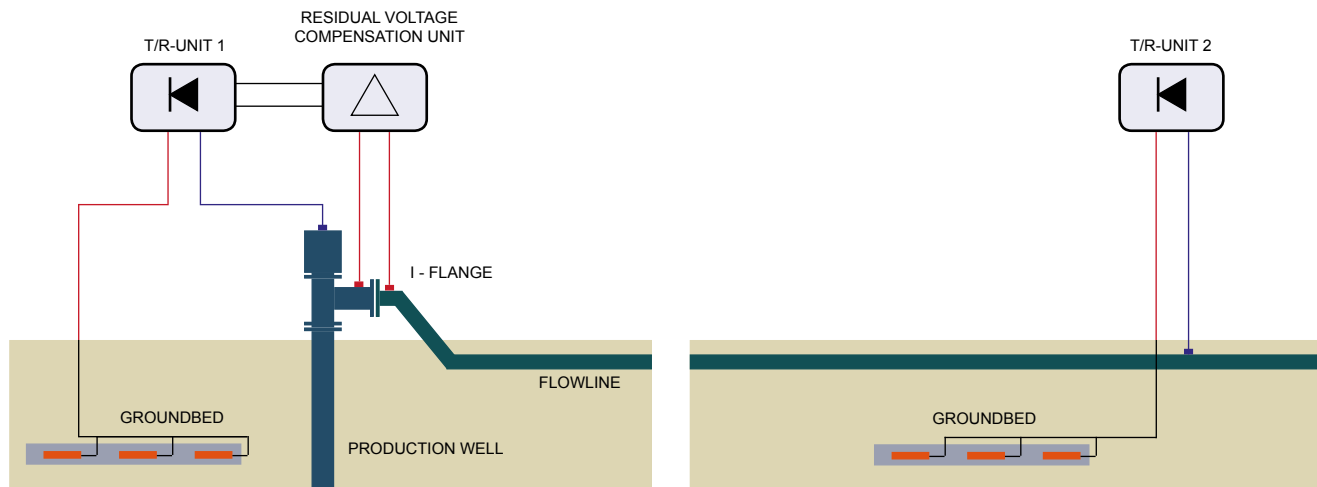

TRANSFORMER RECTIFIERS

Selection guide

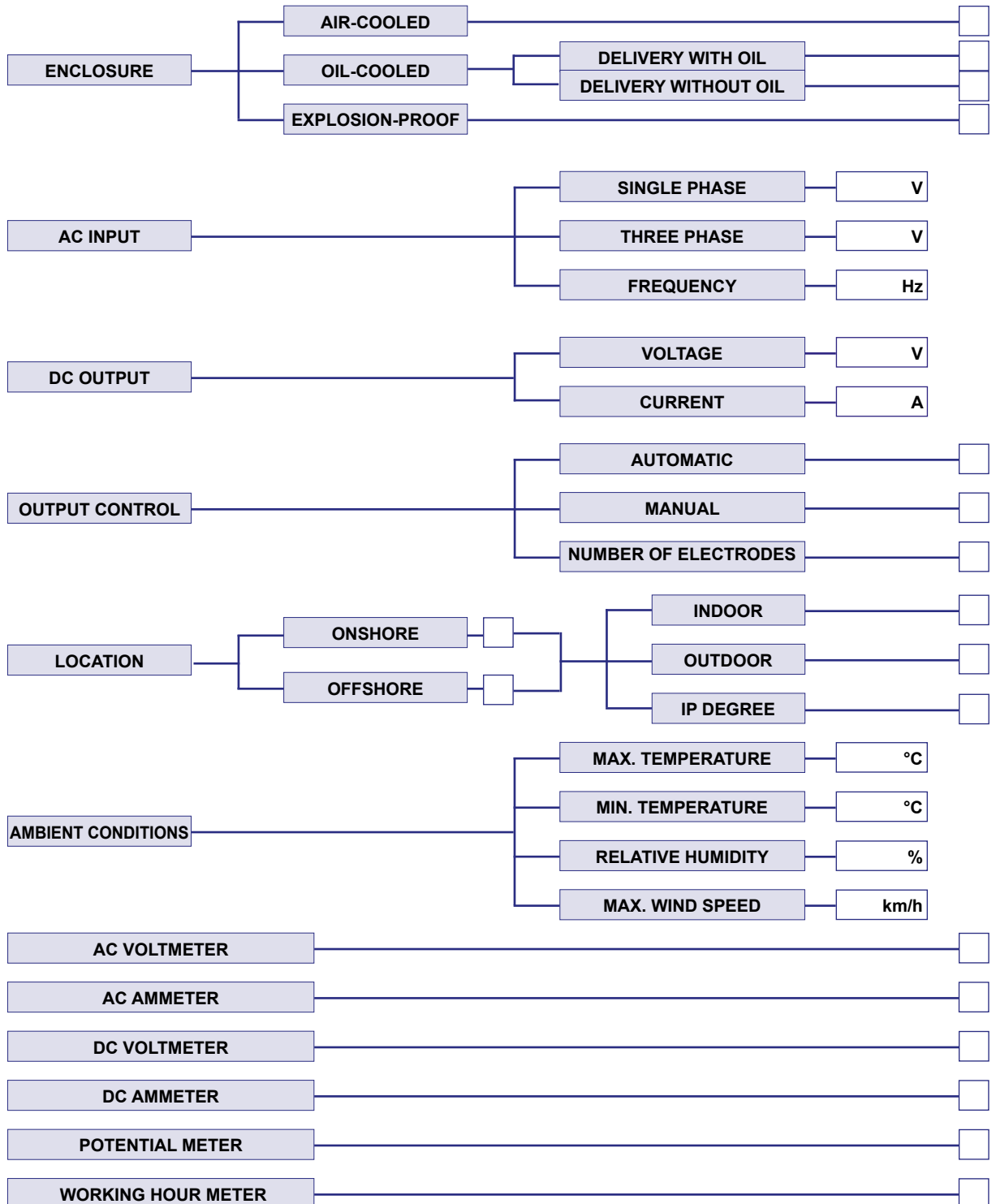

TRANSFORMER RECTIFIERS

Selection guide

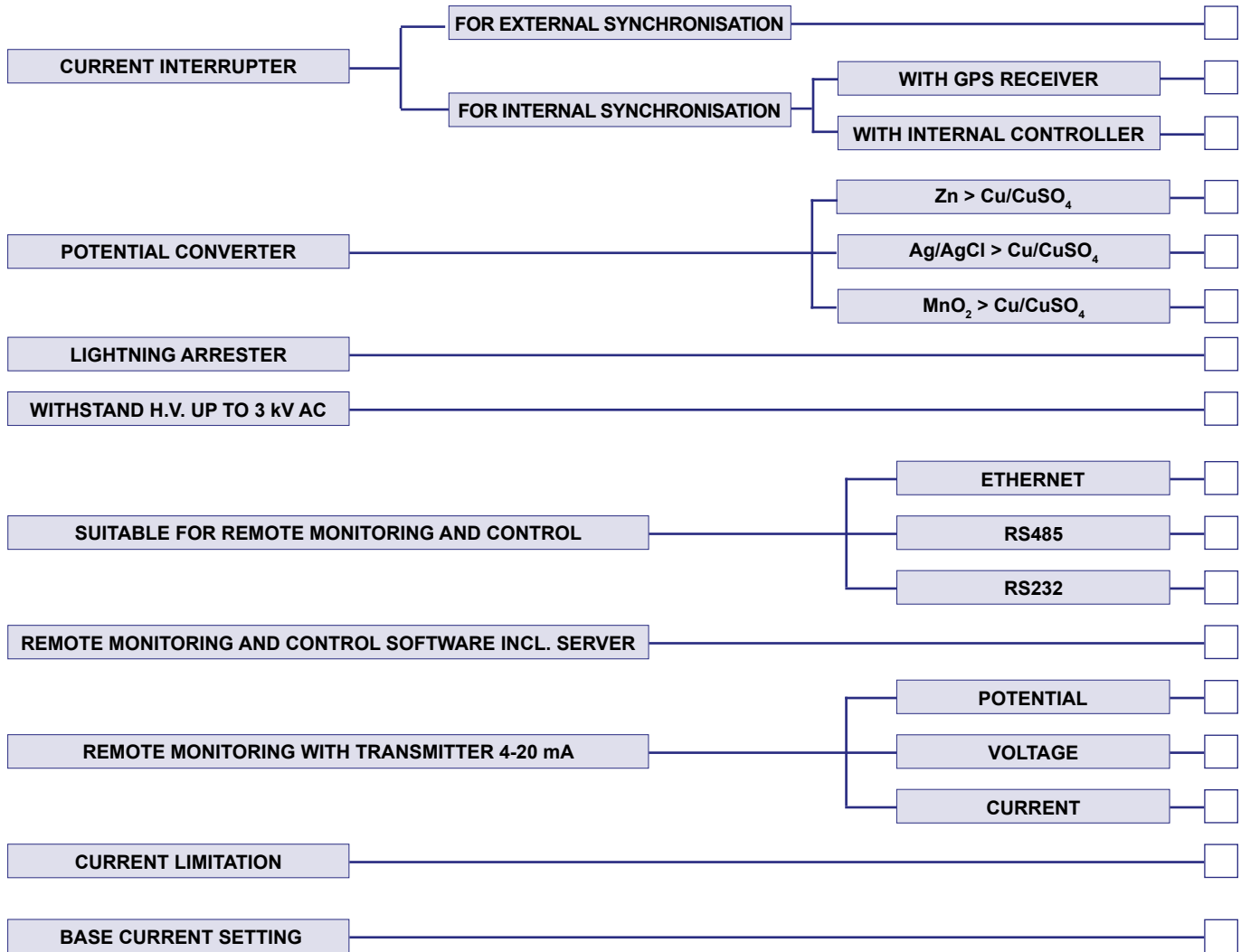

Other Requirements